

HI MOD HT/HTS Combo Unit

EtherNet/IP™

INTRODUCTION

HI-MOD HT is a series of stepping motors in three sizes with integrated ministep bipolar chopper drives and STO Function, based on battery-less multi-turn absolute encoder.

- Also available with other interfaces:

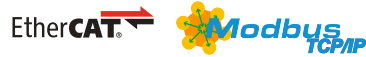

HIGHLIGHTS

- New generation Full Closed Loop 
- Battery-less Multi-turn ABSOLUTE ENCODER
- Holding Torque up to 920 Ncm
- Communication by means of EtherNet/IP interface
- Different Operation Modes
- Available Inputs / Outputs
- Touch probe hardware input
- AUTO-SYNC function
- STO Function - SIL3 with Error Detection Monitor

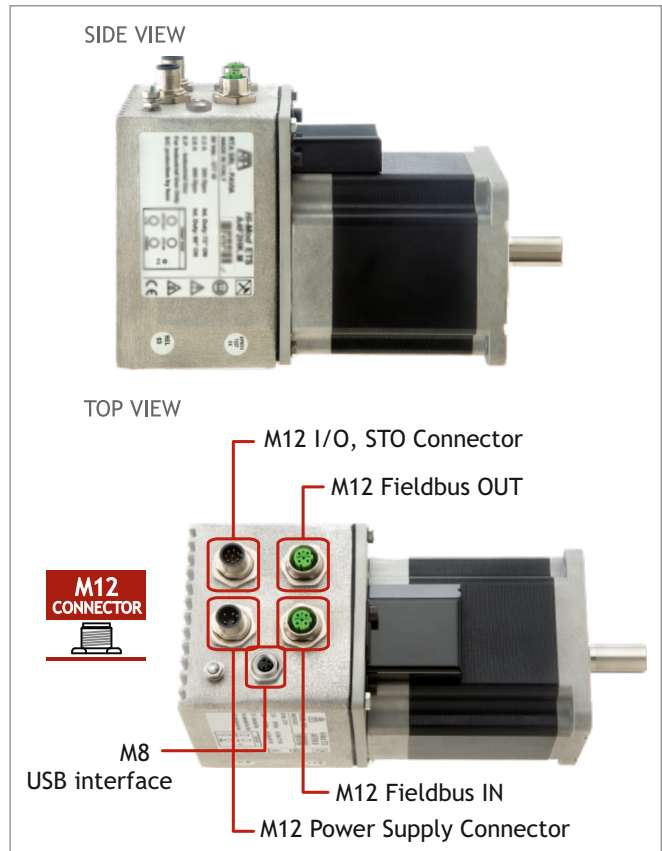

Front Brake and/or Gearbox versions available

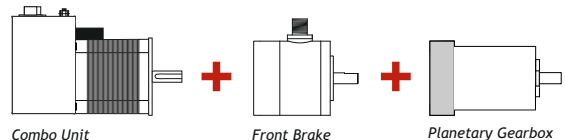

SCAN THE QR CODE TO WATCH A VIDEO ON THE AUTO-SYNC FUNCTION



Please refer to download.rta.it for technical specifications

Models	Motor Length (mm)	Holding Torque (Ncm)	Encoder Type	Digital In/Out	STO	Rated Voltage (VDC)
HI-MOD HTS A4K2HN.M <i>Full Closed Loop</i>	96.5	700	Battery-less Multi-turn Absolute	1/2	✓	48-80
HI-MOD HT A5K2HN.M <i>Full Closed Loop</i>	96.5	700	Battery-less Multi-turn Absolute	2/2	X	48-80
HI-MOD HTS A4K2RN.M <i>Full Closed Loop</i>	96.5	700	Battery-less Multi-turn Absolute	1/2	✓	80-140
HI-MOD HT A5K2RN.M <i>Full Closed Loop</i>	96.5	700	Battery-less Multi-turn Absolute	2/2	X	80-140

140 VDC

140 VDC

Other models upon request

SIZES AND PERFORMANCES

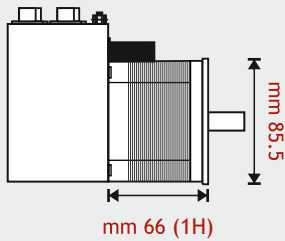

Holding Torque: 360 Ncm

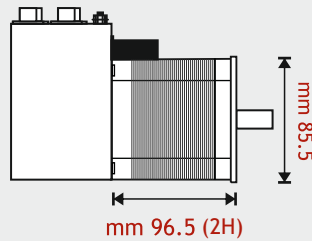

Holding Torque: 700 Ncm

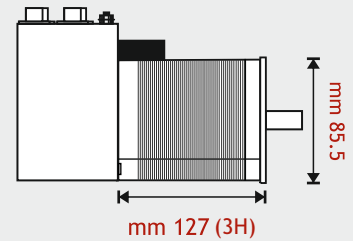

Holding Torque: 920 Ncm

CONNECTION SCHEME

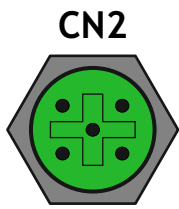

Fieldbus
OUT



Fieldbus
IN

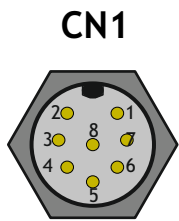

I/O



POWER

CN5



USB
interface

TORQUE/SPEED CURVE

48/80/140 VDC TORQUE/SPEED CURVE - REF. 700 Ncm MODELS

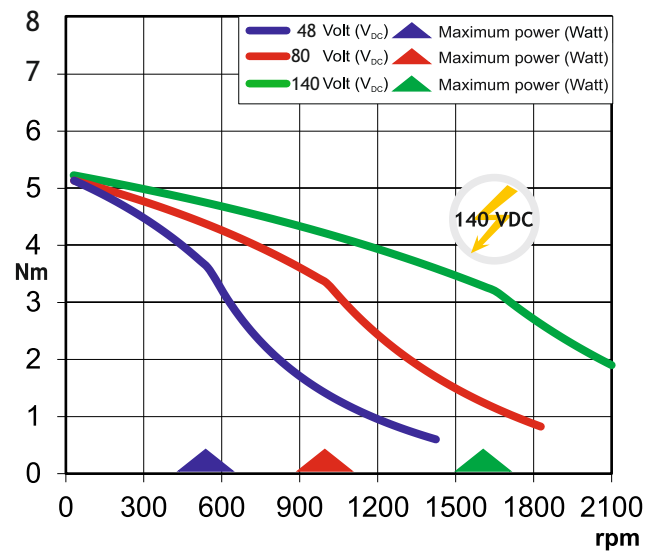

MECHANICAL DIMENSIONS (mm)

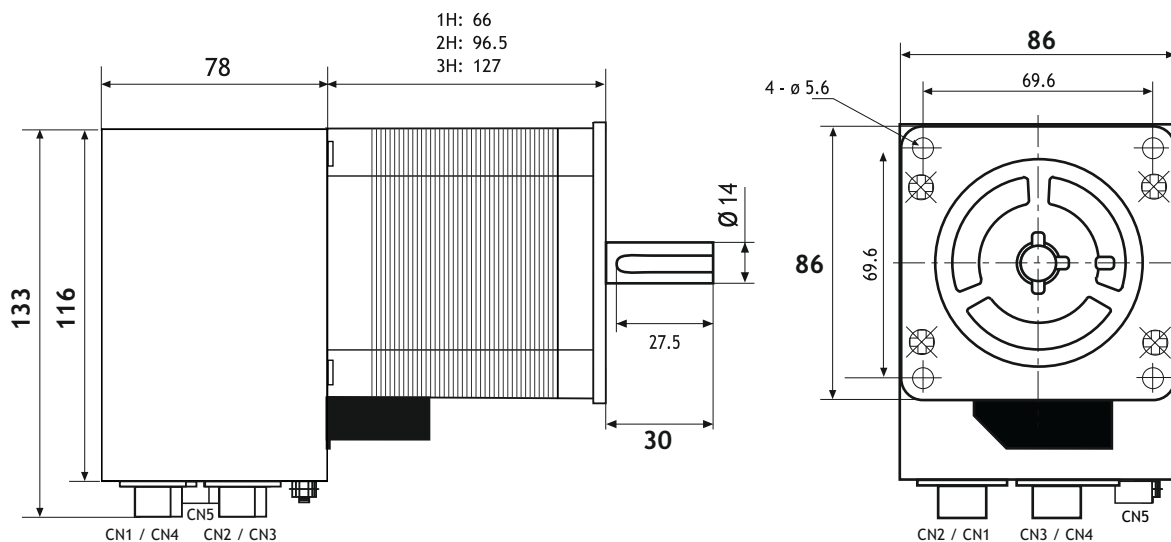

Starter kit and cable set available.



R.T.A. s.r.l.
Via E. Mattei - Fraz- Divisa
27020 Marcignago (PV) (Italy)
T +39.0382.929.855
F +39.0382.929.150
www.rta.it

R.T.A. Deutschland GmbH
Bublitzer Strasse 34, 40599
Duesseldorf (Germany)
T +49.211.749.668.60
F +49.211.749.668.66
www.rta-deutschland.de

R.T.A. INDIA Pvt
Teerth Business Center 3rd Floor, Unit No. 7,
Block EL-15, MIDC Bhosari Pimpri-Chinchwad,
Pune 411026 (India)
Tel. +91 9422507445
www.rta-india.in