

SP2861-51SX01

SANYO DENKI
SANMOTION

Dimensions (Unit:mm)

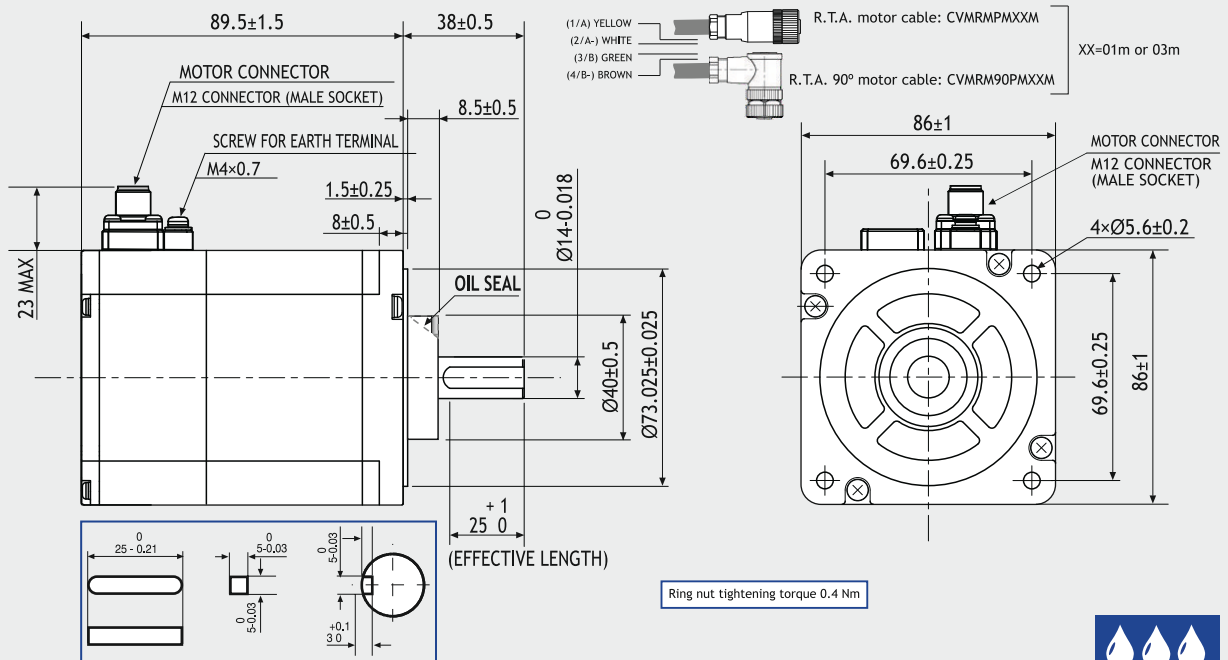

FEATURES

	MODEL	SP2861-51SX01
BASIC STEP ANGLE		1.8° ± 0.09°
BIPOLAR CURRENT	(Amp)	4.0
RESISTANCE	(Ohm)	0.56
INDUCTANCE	(mH)	3.7
BIPOLAR HOLDING TORQUE	(Ncm)	360
ROTOR INERTIA	(Kg·m ² × 10 ⁻⁷)	1480
THEORETICAL ACCELERATION	(rad × sec. ⁻²)	24300
BACK E.M.F.	(V/Krpm)	90
MASS	(Kg)	1.9
INTERNATIONAL STANDARDS		UL, CSA, CE, RoHS
INSULATION VOLTAGE	(V)	250 V _{AC} (350 V _{DC})
PROTECTION DEGREE - INSULATION CLASS		FULL IP65 - F
LEADS CODE		V

TORQUE/SPEED CURVE

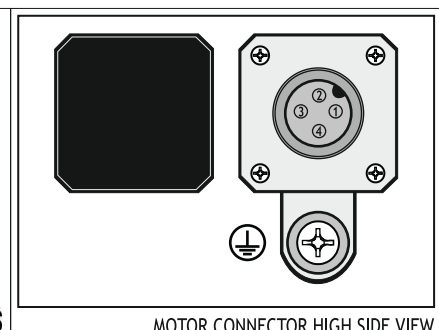
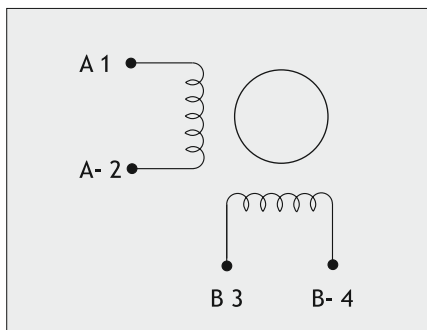
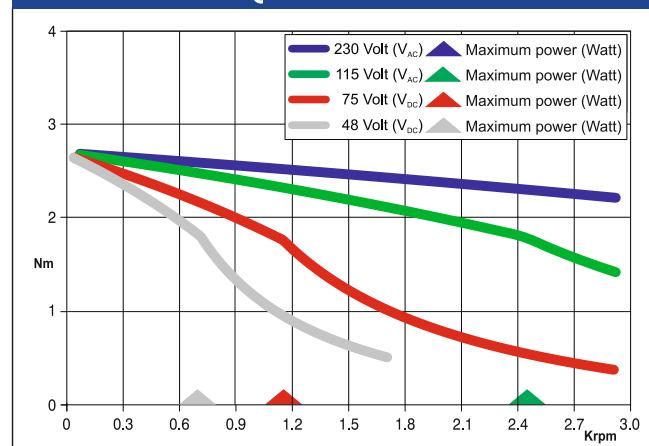

Suggested R.T.A. drive series: 230 Vac X-PLUS



R.T.A. s.r.l.
Via E. Mattei - Fraz- Divisa
27020 Marcignago (PV) (Italy)
T +39.0382.929.855
F +39.0382.929.150
www.rta.it

R.T.A. Deutschland GmbH
Bublitzter Strasse 34, 40599
Duesseldorf (Germany)
T +49.211.749.668.60
F +49.211.749.668.66
www.rta-deutschland.de

R.T.A. IBERICA
C/Generalitat 22, Local 1
08850 Gava - Barcelona (Spain)
T +34 936.388.805
F +34 936.334.595
www.rta-iberica.es

R.T.A. INDIA Pvt
Teerth Business Center 3rd Floor, Unit No. 7,
Block EL-15, MIDC Bhosari Pimpri-Chinchwad,
Pune 411026 (India)
Tel. +91 9422507445
www.rta-india.in